



## Features

- Up to 80% energy saving compared to traditional halogen AR111
- Long lifetime of 30,000 hours with 2 years warranty
- Narrow and wide beam angle is option for different application.
- Dimmable with trailing edge dimmers.
- Aluminum fin body with excellent heat conduction ability and shock resistant
- Radiation free, no UV nor IR
- RoHS compliant, environmental friendly

## Applications

- All indoor lighting purpose, but not used in high temperature, moisture area and enclosed fixtures.

## Equivalent

12W LED  $\cong$  50W halogen

## Technical Specifications and Ordering Part Number

Part Number	Specification of LED chip				Specification of LED lamp					
	Brand/Model	Color Temp. (CCT)	Lumens (@Tj 25°C)	CRI (Typ.)	Volts	Watts (Max.)	Base	Angle	Efficacy (lm/w)	Dimmable
9AR-1112-WS7	Cree CXA1507	3000K	1000	80	AC 12V	12W	G53	24°	50	YES
9AR-1112-CS7	Cree CXA1507	5000K	1150	75	AC 12V	12W	G53	24°	61	YES
9AR-1112-WA7	Cree CXA1507	3000K	1000	80	AC 12V	12W	G53	32°	50	YES
9AR-1112-CA7	Cree CXA1507	5000K	1150	75	AC 12V	12W	G53	32°	61	YES
9AR-1112-WW7	Cree CXA1507	3000K	1000	80	AC 12V	12W	G53	110°	50	YES
9AR-1112-CW7	Cree CXA1507	5000K	1150	75	AC 12V	12W	G53	110°	61	YES

- Specifications of LED chips listed above are provided by the LED manufacturer.
- Lumens of LED chips are calculated for reference only.
- Lamp efficacy is measured according to LM79 standards.
- Higher CRI or other CCT LED may be available. Please consult with your sales representative.
- Product specifications are subject to change without notice.

## Dimension Drawing

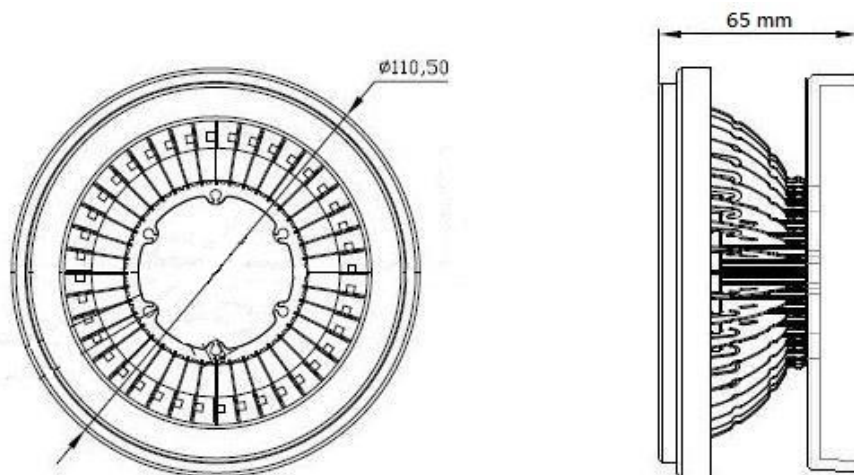

## Weight & Packaging

- ※ Net weight: 125 g
- ※ 1 piece of LED AR111 is packed into a paper box in the measurements of 18x13x7 cm and weight of 220g (without transformer).
- ※ 13 pieces (boxes) of LED AR111 are packed into an export carton in the measurements of 30x31x36 cm (1.2' Cuft.) and weight of 3.5 Kgs.

## LUX DISTANCE CURVE & LIGHT DISTRIBUTION CURVE

### P/N. 9AR-1112-WS7 (24° beam angle)

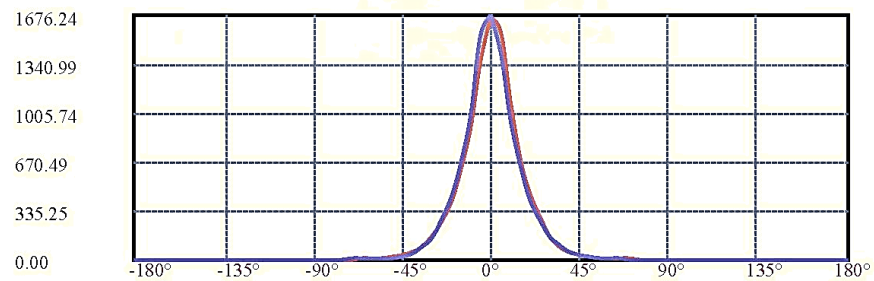
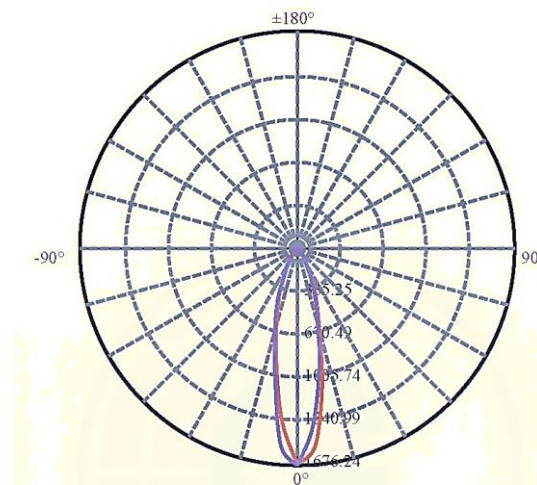
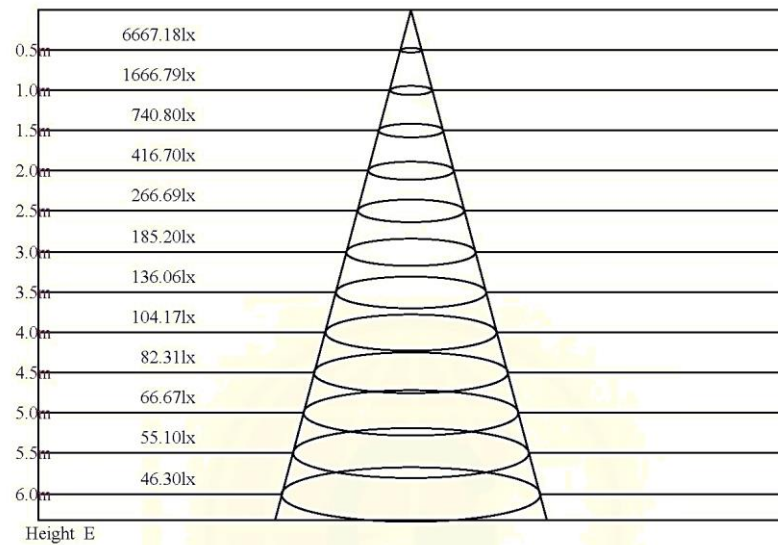

C0/C180: ————  
C90/C270: ————

**P/N. 9AR-1112-WW7 (110° beam angle)**

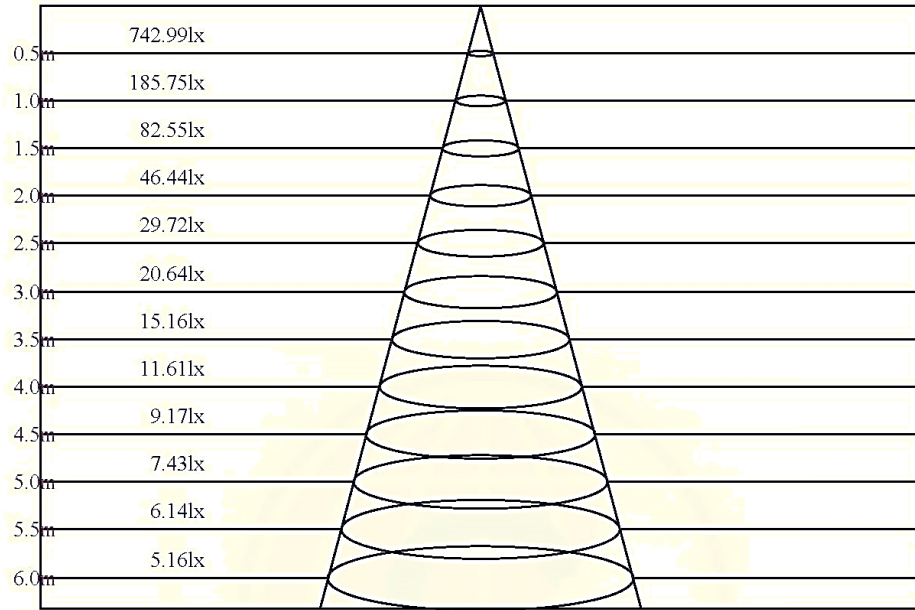

Height E

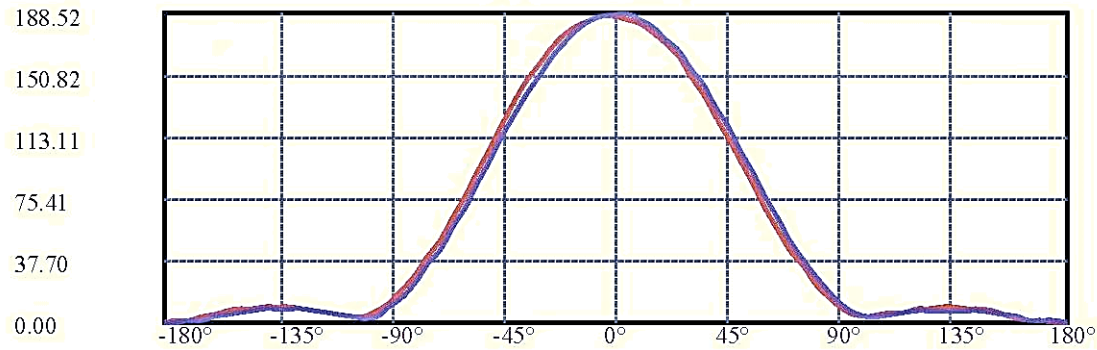
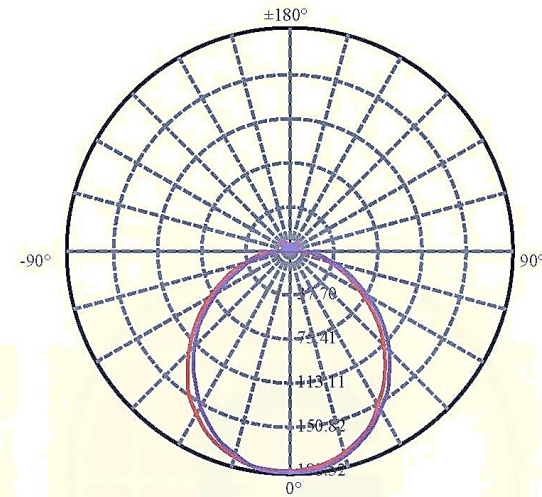

C0/C180: —

C90/C270: —

**P/N. 9AR-1112-CW7 (110° beam angle)**

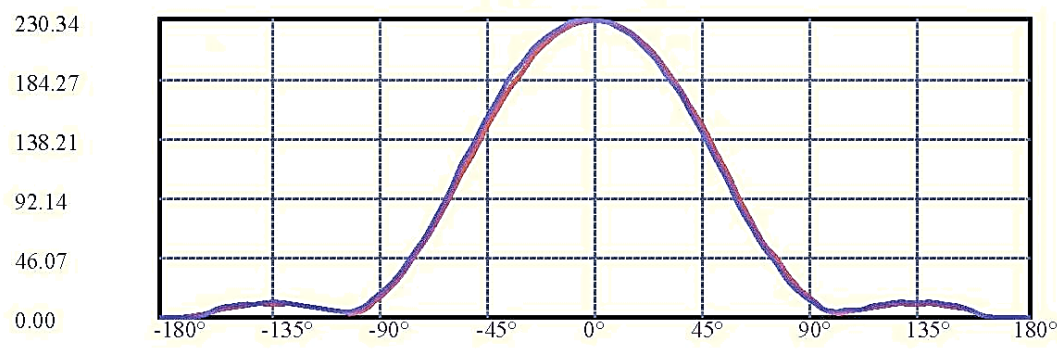
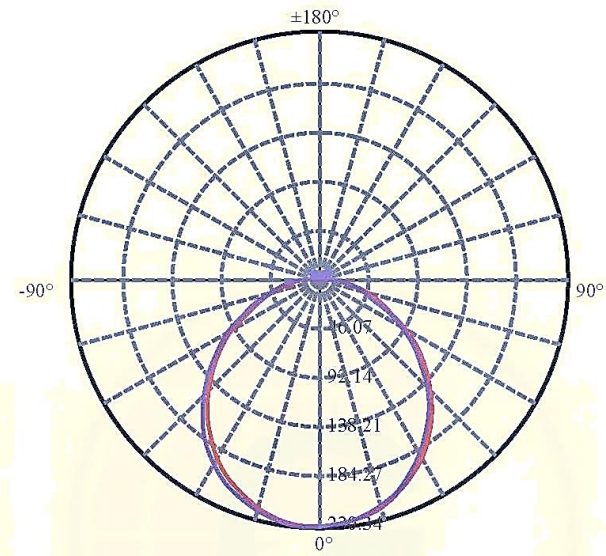
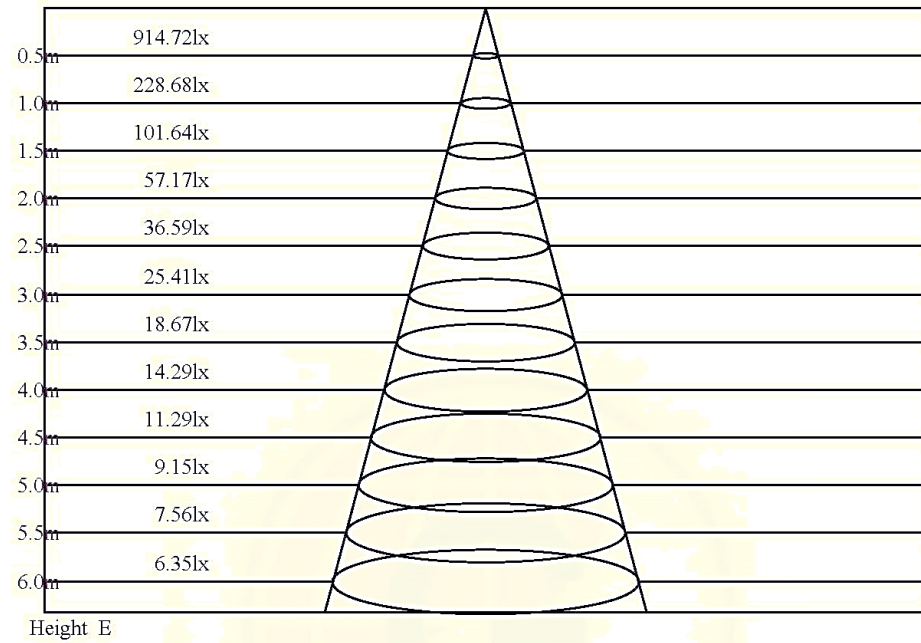

C0/C180: —  
 C90/C270: —

## Application Notes

- Turn OFF the power from fixture before installation.
- The dimmable lamp is mainly designed to work with Trailing Edge dimmers and AC electronic transformer. **Not intended for DC operations.**  
Real dimming performance depends on the combination of dimmer and transformer. Please refer to our compatibility test data.
- This product is not water-proof, please do not use in water, outdoor. For indoor use only.
- If the current light fixture has a cover in front, please remove it (if possible) for better optic and heat exchange.
- Do not use in totally enclosed fixture, excessive or continuous heat built-up will drastically reduce the life of the LED lamp. Well ventilated and open fixtures are the best for proper light output and product life.
- Not suitable for high temperature and moisture area, such as bathroom..
- User should be cautioned not to stare at the light. The bright light can damage eyes.
- The applied ambient temperature must be lower than 40 °C.

## Long-term lumen and color maintenance

LED lamps typically donot fail to emit light but will decrease in light output and cause color shift over time. The light output decrease amount and time of occurring color shift will vary with different using conditions, ie. higher ambient temp., poor fixture design..etc. To keep the LED lights working at lower temperature environment and well ventilation of fixture are the key issues to maintain better light output and color performance.

## Environmental Compliance

U-TEL LED lamps are compliant to the European Union Directives on the restriction of hazardous substances in electronic equipment, namely the RoHS directive. U-TEL will not intentionally add the restricted materials to her LED lighting products, including lead, mercury, cadmium, hexavalent chromium, polybrominated biphenyls (PBB) or polybrominated diphenyl ethers (PBDE).

## PRODUCT WARRANTY POLICY

### Products warranty

U-TEL warrants her LED lamp products to be free from defects in material and workmanship for a period of 24 months starting from the shipment date. During the warranty period, the product fails to operate under normal use, U-TEL will repair or replace the defective products in accordance with the terms and conditions stipulated below.

## **Definition of Defectiveness**

1. U-TEL's customers should purchase samples before placing quantity orders. The sample(s) will have to be approved by customers in written. The quality of that approved samples will be used as a quality reference in case of defective units. If returned units are considered of like quality and level of performance to the reference sample, they will not be covered by the warranty. If the customer chooses not to test / confirm samples before ordering, then defectiveness refers to those items which obviously cannot serve its purpose.
2. General definition of defectiveness after using is the LED light to become non-function (emit no light) at normal working conditions.

## **Procedure of RMA**

1. Before returning the defectives, customers need to test each unit and the defective reasons must be clearly marked in the RMA form (provided BY U-TEL).
2. The returned product should be packed carefully to avoid damage during transport.
3. Customers will be responsible to arrange the defectives back to U-TEL and prepay shipping charges.
4. U-TEL will ship the repaired or replacement products to customers (freight prepaid by U-TEL).

## **Exclusion from warranty**

This warranty will not cover the following situations:

1. If the products have been disassembled.
2. Damage due to the usage not in accordance with product instructions and cautions.
3. If the product sticker on the product has been tampered or removed.
4. If the products still can fully work with the light fixture/transformer tested by U-TEL.
5. This warranty shall not cover incidents due to per chance circumstances outside one's control, misuse, modification, acts of God, improper ventilation and damages resulting from water.

If U-TEL repairs or replaces a product, its warranty period is not extended.