

PhlatLight[®] White LED Illumination Products

CST-90 Series

Features

- Extremely high optical output: Over 2,750 lumens from a single chip (White)
- Extremely high efficiency: Over 100 lumens per watt at 350 mA/mm²
- High thermal conductivity package - junction to heat sink thermal resistance of only 0.9 °C/W
- Large, monolithic chip with uniform emitting area of 9 mm²
- Lumen maintenance of greater than 70% after 60,000 hours
- Environmentally friendly: RoHS compliant
- Variable drive currents: less than 1 A through 13.5 A to full reliability specifications
- High reliability

Applications

- Architectural Lighting
- Retail Lighting
- Residential Lighting
- Consumer Portable
- Spot Lighting
- High Bay Lighting
- Wide Area Lighting
- Street Lighting

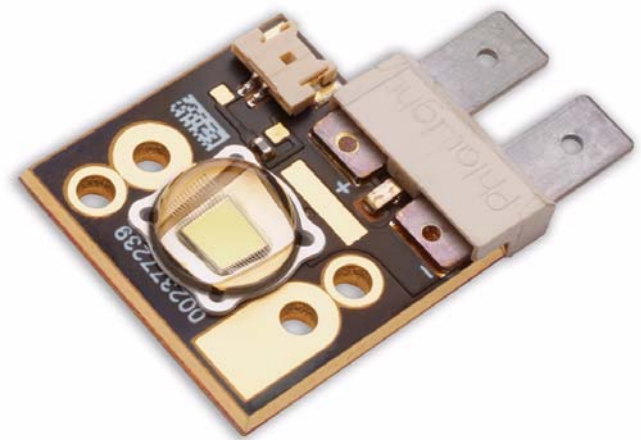

PhlatLight[®] LEDs enable a new class of illumination applications.

Table of Contents

Technology Overview.....	2
Test Specifications.....	2
PhlatLight Bin Codes.....	3
Product Shipping and Labeling Information.....	7
Optical and Electrical Characteristics	8
Lifetime and Lumen Maintenance	9
Spectral Characteristics.....	9
Radiation Patterns	10
Thermal Resistance	10
Mechanical Dimensions.....	11
Ordering Information	12

Technology Overview

PhlatLight LEDs benefit from a suite of innovations in the fields of chip technology, packaging, and thermal management. These breakthroughs allow illumination designers to achieve efficient light engine designs and deliver high brightness solutions.

PhlatLight Technology

The name PhlatLight is derived from Photonic Lattice. Photonic lattice technology creates true surface emission from the source, which enables large area LED chips with uniform brightness over the entire LED chip surface. The optical power and brightness produced by these large monolithic chips enable solutions which replace arc and halogen lamps where arrays of traditional high power LEDs cannot.

Packaging Technology

Thermal management is critical in high power LED applications. With a thermal resistance from junction to heat sink of 0.9 °C/W, PhlatLight CST-90 devices have the lowest thermal resistance of any LED on the market. This allows the LED to be driven at higher current densities while maintaining a low junction temperature, thereby resulting in brighter and longer lifetimes. The package is easy to use, and ready to be mounted in the lighting system.

Reliability

Designed from the ground up, PhlatLight LEDs are one of the most reliable light sources in the world today. PhlatLight LEDs have passed a rigorous suite of environmental and mechanical stress tests, including mechanical shock, vibration, temperature cycling and humidity, and have been fully qualified for use in extreme high power and high current applications. With very low failure rates and median lifetimes that are well above 60,000 hours, PhlatLight LEDs are ready for the most demanding applications.

Environmental Benefits

PhlatLight LEDs help reduce power consumption and the amount of hazardous waste entering the environment. All PhlatLight products manufactured by Luminus are RoHS compliant and free of hazardous materials, including lead and mercury.

Understanding PhlatLight Test Specifications

Every PhlatLight LED device is fully tested to ensure that it meets the high quality standards of Luminus' products.

Multiple Operating Points (3.2 A, 13.5 A)

The tables on the following pages provide typical optical and electrical characteristics. Since the LEDs can be operated over a wide range of drive conditions (currents from less than 1 A to 13.5 A, and duty cycle from <1% to 100%) multiple drive conditions are listed.

PhlatLight CST-90 devices are production tested at 3.2 A. The values shown at 13.5 A are for additional reference at other possible drive conditions.

PhlatLight White Binning Structure

PhlatLight CST-90 White LEDs are tested for luminous flux and chromaticity at a drive current of 3.2 A (0.35 A/mm²) and placed into one of the following luminous flux (FF) and chromaticity (WW) bins:

Flux Bins

Color	Flux Bin (FF)	Minimum Flux (lm) @ 3.2 A	Maximum Flux (lm) @ 3.2 A
W65S 6500K, Standard CRI (typ. 70)	WK	600	700
	WL	700	850
	WM	850	1,000
	WN	1,000	1,200
W57S 5700K, Standard CRI (typ. 70)	WK	600	700
	WL	700	850
	WM	850	1,000
	WN	1,000	1,200
W45S 4500K, Standard CRI, (typ. 70)	WJ	500	600
	WK	600	700
	WL	700	850
	WM	850	1,000
W40M 4000K, Moderate CRI, (typ. 70)	WJ	500	600
	WK	600	700
	WL	700	850
	WM	850	1,000
W30M 3000K, Moderate CRI, (typ. 83)	WH	425	500
	WJ	500	600
	WK	600	700
	WL	700	850

Chromaticity Bins

Luminus' Standard Chromaticity Bins: 1931 CIE Curve

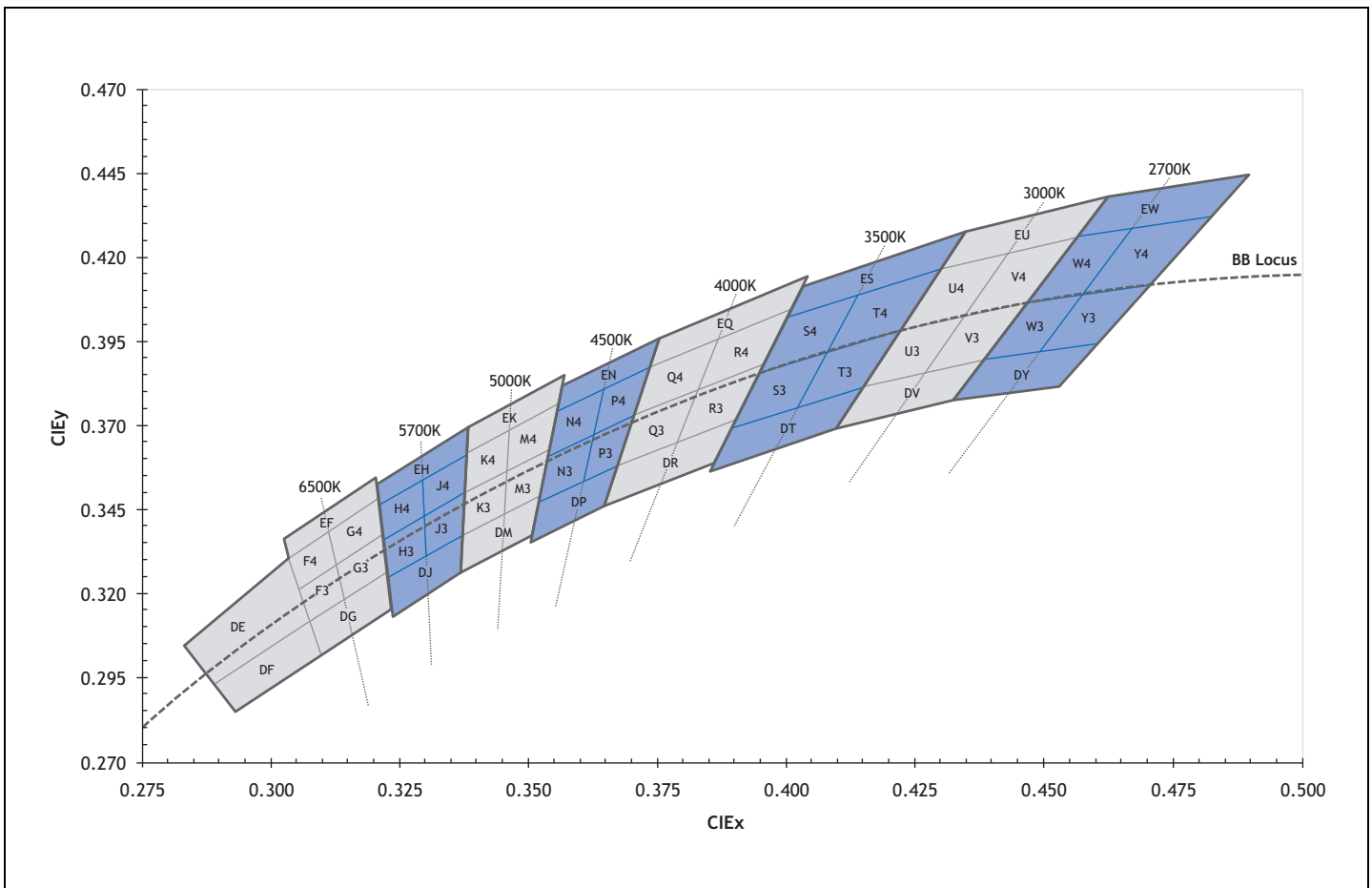

The following tables describe the four chromaticity points that bound each chromaticity bin. Chromaticity bins are grouped together based on the color temperature.

6500K Chromaticity Bins		
Bin Code (WW)	CIE _x	CIE _y
DG	0.307	0.311
	0.322	0.326
	0.323	0.316
	0.309	0.302
F3*	0.305	0.321
	0.313	0.329
	0.315	0.319
	0.307	0.311
F4*	0.303	0.330
	0.312	0.339
	0.313	0.329
	0.305	0.321
G3*	0.313	0.329
	0.321	0.337
	0.322	0.326
	0.315	0.319
G4*	0.312	0.339
	0.321	0.348
	0.321	0.337
	0.313	0.329
EF	0.302	0.335
	0.320	0.354
	0.321	0.348
	0.303	0.330
DE	0.283	0.304
	0.303	0.330
	0.307	0.311
	0.289	0.293
DF	0.289	0.293
	0.307	0.311
	0.309	0.302
	0.293	0.285

5700K Chromaticity Bins		
Bin Code (WW)	CIE _x	CIE _y
DJ	0.322	0.324
	0.337	0.337
	0.336	0.326
	0.323	0.314
	0.321	0.335
H3*	0.329	0.342
	0.329	0.331
	0.322	0.324
	0.321	0.346
H4*	0.329	0.354
	0.329	0.342
	0.321	0.335
	0.329	0.342
J3*	0.329	0.342
	0.337	0.349
	0.337	0.337
	0.330	0.331
J4*	0.329	0.354
	0.338	0.362
	0.337	0.349
	0.329	0.342
EH	0.320	0.352
	0.338	0.368
	0.338	0.362
	0.321	0.346

5000K Chromaticity Bins		
Bin Code (WW)	CIE _x	CIE _y
EK	0.338	0.368
	0.356	0.384
	0.355	0.376
	0.338	0.362
K3*	0.337	0.349
	0.345	0.355
	0.345	0.343
	0.337	0.337
K4*	0.338	0.362
	0.347	0.369
	0.345	0.355
	0.337	0.349
M3*	0.345	0.355
	0.353	0.362
	0.352	0.349
	0.344	0.343
M4*	0.346	0.369
	0.355	0.376
	0.353	0.362
	0.345	0.355
DM	0.337	0.337
	0.352	0.349
	0.350	0.337
	0.336	0.326

* Sub-bins within ANSI defined quadrangles per ANSI C78.377-2008

PRELIMINARY

4500k Chromaticity Bins		
Bin Code (WW)	CIE _x	CIE _y
EN	0.356	0.384
	0.376	0.396
	0.374	0.387
	0.355	0.374
N3*	0.353	0.360
	0.361	0.366
	0.359	0.352
	0.351	0.347
N4*	0.355	0.374
	0.364	0.381
	0.361	0.366
	0.353	0.360
P3*	0.361	0.366
	0.370	0.373
	0.367	0.358
	0.359	0.352
P4*	0.364	0.381
	0.374	0.387
	0.370	0.373
	0.361	0.366
DP	0.351	0.347
	0.367	0.358
	0.364	0.346
	0.350	0.335

4000K Chromaticity Bins		
Bin Code (WW)	CIE _x	CIE _y
EQ	0.376	0.396
	0.404	0.414
	0.401	0.404
	0.374	0.387
Q3*	0.370	0.373
	0.382	0.380
	0.378	0.365
	0.367	0.358
Q4*	0.374	0.387
	0.387	0.396
	0.382	0.380
	0.370	0.373
R3*	0.382	0.380
	0.395	0.388
	0.390	0.372
	0.378	0.365
R4*	0.387	0.396
	0.401	0.404
	0.395	0.388
	0.382	0.380
DR	0.367	0.358
	0.390	0.372
	0.386	0.359
	0.364	0.346

3500K Chromaticity Bins		
Bin Code (WW)	CIE _x	CIE _y
ES	0.403	0.411
	0.435	0.427
	0.430	0.417
	0.400	0.402
S3*	0.394	0.385
	0.407	0.392
	0.402	0.375
	0.389	0.369
S4*	0.400	0.402
	0.415	0.409
	0.407	0.392
	0.394	0.385
T3*	0.407	0.392
	0.422	0.399
	0.415	0.381
	0.402	0.375
T4*	0.415	0.409
	0.430	0.417
	0.422	0.399
	0.407	0.392
DT	0.389	0.369
	0.415	0.381
	0.409	0.369
	0.385	0.357

3000K Chromaticity Bins		
Bin Code (WW)	CIE _x	CIE _y
EU	0.435	0.427
	0.462	0.437
	0.456	0.426
	0.430	0.417
U3*	0.422	0.399
	0.434	0.403
	0.426	0.385
	0.415	0.381
U4*	0.430	0.417
	0.443	0.421
	0.434	0.403
	0.422	0.399
V3*	0.434	0.403
	0.447	0.408
	0.437	0.389
	0.426	0.385
V4*	0.443	0.421
	0.456	0.426
	0.447	0.408
	0.434	0.403
DV	0.415	0.381
	0.437	0.389
	0.431	0.377
	0.409	0.369

2700K Chromaticity Bins		
Bin Code (WW)	CIE _x	CIE _y
EW	0.462	0.437
	0.488	0.444
	0.481	0.432
	0.456	0.426
W3*	0.447	0.408
	0.458	0.410
	0.448	0.392
	0.437	0.389
W4*	0.456	0.426
	0.469	0.429
	0.458	0.410
	0.447	0.408
Y3*	0.458	0.410
	0.470	0.413
	0.459	0.394
	0.448	0.392
Y4*	0.469	0.429
	0.481	0.432
	0.470	0.413
	0.458	0.410
DY	0.437	0.389
	0.459	0.394
	0.452	0.382
	0.431	0.377

* Sub-bins within ANSI defined quadrangles per ANSI C78.377-2008

PhlatLight Product Shipping and Labeling Information

All PhlatLight products are packaged and labeled with their respective bin as outlined in the tables on pages 3 and 4. Modules are packaged in trays of 10, with each package only containing one bin. The part number designation is as follows:

CST — 90 — WNNX — C12 — FF — WW

Product Family	Chip Area	Color	Package Configuration	Flux Bin	Chromaticity Bin
CST: Chip-on-board	90: 9.0 mm ²	WNNX: CCT and CRI See Note 1 Below	C12: 28 x 27 mm board	See page 3 for bins	See pages 4-6 for bins

Note 1. WNNX nomenclature corresponds to the following:

W = White

NN = color temperature, where:

65 corresponds to 6500K

40 corresponds to 4000K

30 corresponds to 3000K, etc.

X = color rendering index, where:

S (standard) corresponds to a typical CRI of 70

M (moderate) corresponds to a typical CRI of 83

H (high) corresponds to a typical CRI of 92.

Note 2. Some flux and chromaticity bins may have limited availability. Application specific bin kits, consisting of multiple bins, may be available. For ordering information, please refer to page 12 and reference the PhlatLight Binning and Labeling document.

Example: The part label CST-90-W65S-C12-WN-G4 refers to a 6500K standard CRI white, CST-90 module, C12 package configuration, with a flux range of 1,000 to 1,200 lumens and a chromaticity value within the box defined by the four points (0.313, 0.338), (0.321, 0.348), (0.322, 0.336), (0.312, 0.328).

Example: The part label CST-90-W30M-C12-WL-U3 refers to a 3000K moderate CRI white, CST-90 module, C12 package configuration, with a flux range of 700 to 850 lumens and a chromaticity value within the box defined by the four points (0.422, 0.399), (0.434, 0.403), (0.426, 0.386), (0.415, 0.381).

Optical and Electrical Characteristics¹

White				
Drive Condition ²		3.2A	13.5 A	
Parameter	Symbol	Typical Values at Test Current	Values at Indicated Currents ³	Unit
Current Density	j	0.35	1.5	A/mm ²
Forward Voltage	V _F	3.2	3.7	V

Common Characteristics

	Symbol	Values	Unit
Emitting Area		9.0	mm ²
Emitting Area Dimensions		3 x 3	mmxmm
Forward Voltage Temperature Coefficient ⁴		-2.45	mV/°C

Absolute Maximum Ratings

	Symbol	Values	Unit
Maximum Current ⁵		13.5	A
Maximum Junction Temperature ⁶	T _{J-max}	150	°C
Storage Temperature Range		-40/+100	°C

Note 1: All ratings are based on operation with a junction temperature $T_j = 25^\circ\text{C}$, 20 millisecond pulse. See Thermal Resistance section for T_j definition.

Note 2: Listed drive conditions are typical for common applications. PhlatLight CST-90-W devices can be driven at currents ranging from less than 1 A to 13.5 A and at duty cycles ranging from 1% to 100%. Drive current and duty cycle should be adjusted as necessary to maintain the junction temperature desired to meet application lifetime requirements.

Note 3: Unless otherwise noted, values listed are typical.

Note 4: Forward voltage temperature coefficient at current density of 0.35 A/mm². Contact Luminus for value at other drive conditions.

Note 5: Luminus PhlatLight CST-90 LEDs are designed for operation to an absolute maximum forward drive current density of 1.5 A/mm². Product lifetime data is specified at recommended forward drive currents. Sustained operation at absolute maximum currents will result in a reduction of device lifetime compared to recommended forward drive currents. Actual device lifetimes will also depend on junction temperature. Refer to the lifetime derating curves for further information. In pulsed operation, rise time from 10-90% of forward current should be larger than 0.5 microseconds.

Note 6: Lifetime dependent on LED junction temperature. Thermal calculations based on input power and thermal management system should be performed to ensure T_j is maintained below T_{jmax} rating or life may be reduced. Refer to lifetime plots on pg 8 and lifetime and reliability application note for further information.

Note 7: CIE measurement uncertainty for white devices is estimated to be +/- 0.01.

Note 7: Special design considerations must be observed for operation under 1 A. Please contact Luminus for further information.

Note 8: Caution must be taken not to stare at the light emitted from these LEDs. Under special circumstances, the high intensity could damage the eye.

Relative Output Flux vs. Forward Current¹

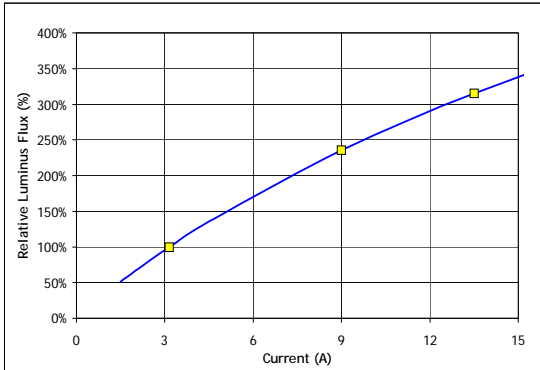

Forward Current vs. Forward Voltage

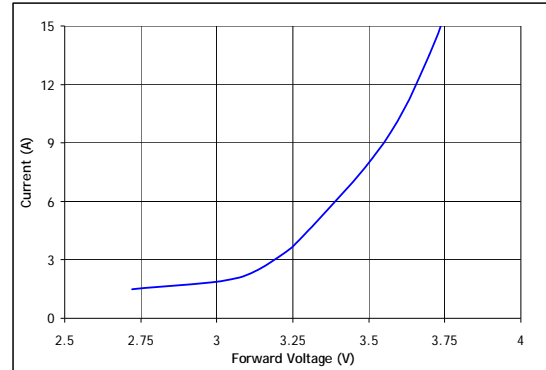

Mean Lifetime²

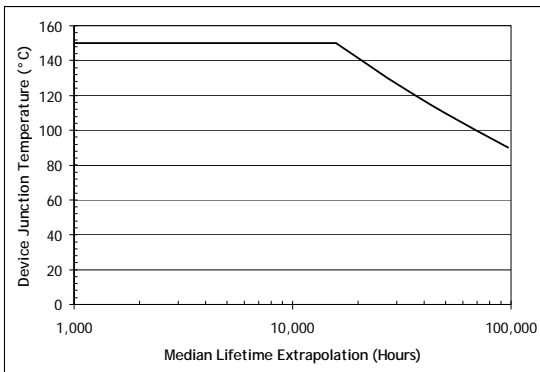

Lumen Maintenance vs. Time³

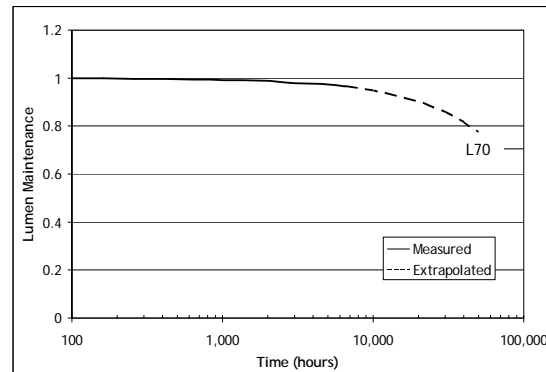

Typical Spectrum⁴

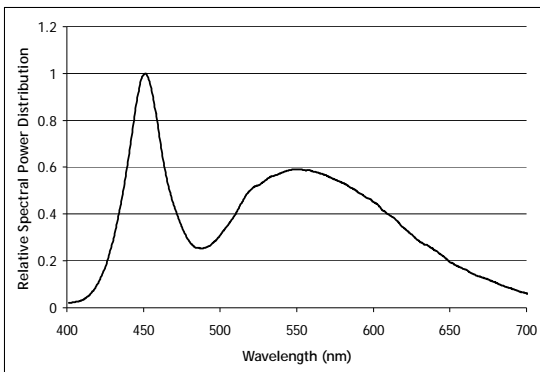

Current Derating Curve

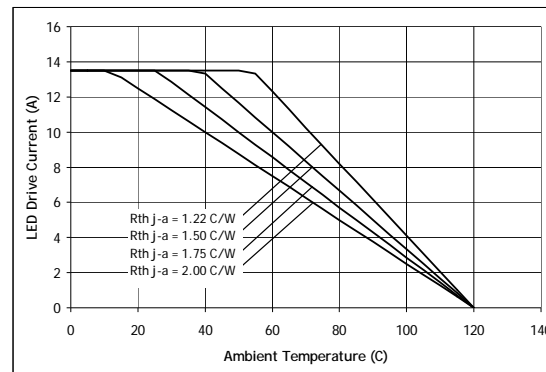

1. Yellow squares indicate typical operating conditions.
2. Mean expected lifetime in dependence of junction temperature at 0.35 A/mm² in continuous operation. Lifetime defined as time to 70% of initial intensity. Based on lifetime test data for uncoated GaN devices at this time. Data can be used to model failure rate over typical product lifetime.
3. Lumen maintenance in dependence of time at 0.35 A/mm² in continuous operation with junction temperatures of 100 °C.
4. Typical spectrum at current density of 0.35 A/mm² in continuous operation.

Typical Radiation Pattern

Typical Polar Radiation Pattern for White

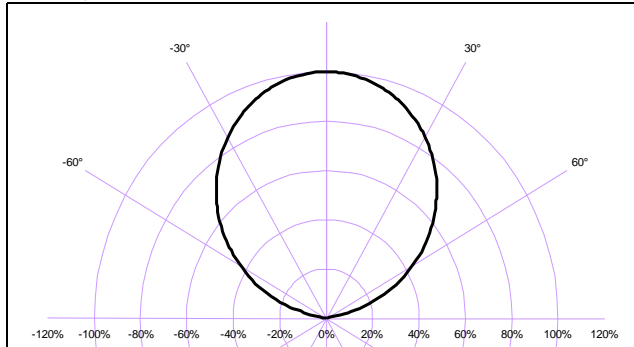

Typical Angular Radiation Pattern for White

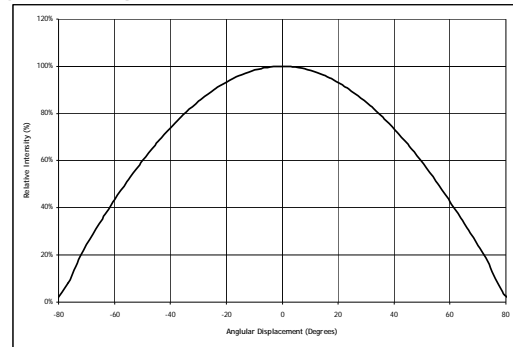

Thermal Resistance

The diagram shows a cross-section of the LED assembly. From top to bottom: a dome-shaped LED die, a die junction, a thermistor, a copper core-board, thermal interface material, and a heat sink. Temperature measurement points are labeled: T_j (die junction), T_b (base of die), T_{ref} (thermistor), T_{hs} (heat sink surface), and T_a (ambient). A note specifies T_{hs} definition = 3 mm from core-board.

$R_{\theta j-b}^1$	0.80 °C/W
$R_{\theta b-hs}^1$	0.12 °C/W
$R_{\theta j-hs}^2$	0.92 °C/W
$R_{\theta j-ref}^1$	0.83 °C/W

Note 1: Thermal resistance values are based on FEA model results correlated to measured $R_{\theta j-hs}$ data.
Note 2: Thermal Resistance is measured using eGraph 1205 Thermal interface.

Thermistor Information

The thermistor used in PhlatLight devices mounted on core-boards is from Murata Manufacturing Co. The global part number is NCP15XH103J03RC. Please see <http://www.murata.com/> for details on calculating thermistor temperature.

Electrical Pinout

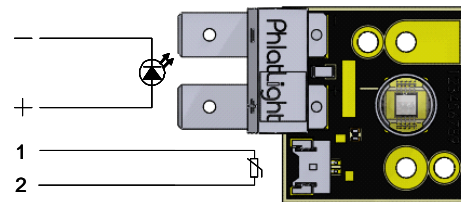

Mechanical Dimensions

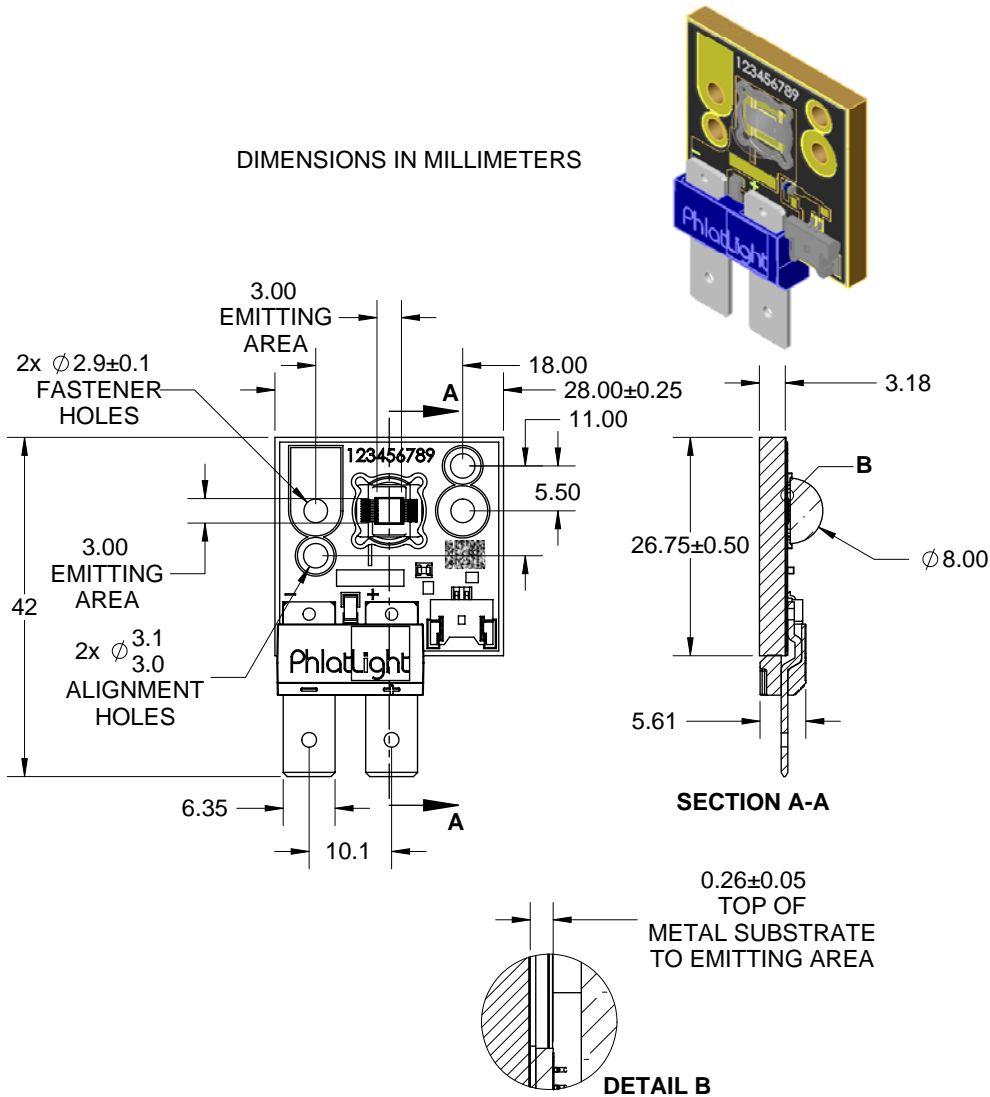

Recommended connector for Anode and Cathode: Panduit Disco Lok™ Series P/N: DNG14-250FL-C
 Thermistor Connector: MOLEX P/N 53780-0270. Recommended Female: MOLEX P/N 51146-0200 or equivalent
 For detailed drawing please refer to DWG-001277 document

Ordering Information

Ordering Part Number ^{1,2,3}	Color	Description
CST-90-W65S-C12-GK100	6500K White	White PhlatLight CST-90 consisting of a domed 9 mm ² LED, thermistor, and connector, mounted on a copper-core PCB.
CST-90-W57S-C12-GK200	5700K White	White PhlatLight CST-90 consisting of a domed 9 mm ² LED, thermistor, and connector, mounted on a copper-core PCB.
CST-90-W45S-C12-GJ400	4500K White	White PhlatLight CST-90 consisting of a domed 9 mm ² LED, thermistor, and connector, mounted on a copper-core PCB.
CST-90-W40M-C12-GJ500	4000K White	White PhlatLight CST-90 consisting of a domed 9 mm ² LED, thermistor, and connector, mounted on a copper-core PCB.
CST-90-W30M-C12-GH700	3000K White	White PhlatLight CST-90 consisting of a domed 9 mm ² LED, thermistor, and connector, mounted on a copper-core PCB.

Note 1: GK100 - denotes a bin kit comprising of all flux and chromaticity bins at the 6500K color point.

GK200 - denotes a bin kit comprising of all flux and chromaticity bins at the 5700K color point.

GJ400 - denotes a bin kit comprising of all flux and chromaticity bins at the 4500K color point.

GJ500 - denotes a bin kit comprising of all flux and chromaticity bins at the 4000K color point.

GH700 - denotes a bin kit comprising of all flux and chromaticity bins at the 3000K color point.

See PhlatLight Binning and Labeling document for more information.

Note 2: For ordering information on all available bin kits, please see PhlatLight Binning and Labeling document.

Note 3: Standard packaging increment (SPI) is 10.

www.luminus.com

The products, their specifications and other information appearing in this document are subject to change by Luminus Devices without notice. Luminus Devices assumes no liability for errors that may appear in this document, and no liability otherwise arising from the application or use of the product or information contained herein. None of the information provided herein should be considered to be a representation of the fitness or suitability of the product for any particular application or as any other form of warranty. Luminus Devices' product warranties are limited to only such warranties as accompany a purchase contract or purchase order for such products. Nothing herein is to be construed as constituting an additional warranty. No information contained in this publication may be considered as a waiver by Luminus Devices of any intellectual property rights that Luminus Devices may have in such information. PhlatLight[®] is a registered trademark of Luminus Devices, Inc., all rights reserved.

This product is protected by U.S. Patents 6,831,302; 7,074,631; 7,083,993; 7,084,434; 7,098,589; 7,105,861; 7,138,666; 7,166,870; 7,166,871; 7,170,100; 7,196,354; 7,211,831; 7,262,550; 7,274,043; 7,301,271; 7,341,880; 7,344,903; 7,345,416; 7,348,603; 7,388,233; 7,391,059; Patents Pending in the U.S. and other countries.